

# Operation Manual WOLTMAN Water Meters

14.11.2007

# Contents

- 1 PURPOSE OF THIS MANUAL AND IMPORTANT INFORMATION .....3**
- 1.1 IMPORTANT INFORMATION CONCERNING THE INSTALLATION OF WATER METERS .....3
- 2 HANDLING AND DIMENSIONING .....4**
- 2.1 HANDLING CARE AND SHIPPING .....4
- 2.2 RECEIPT AND STORAGE .....4
- 2.3 SELECTING PROPER WATER METER SIZES .....4
- 3 INSTALLATION REQUIREMENTS .....5**
- 3.1 GENERAL .....5
- 3.2 INSTALLATION IN RIGID PIPELINES .....6
- 3.3 INSTALLATION IN RIGID PIPELINES WITH DIFFERENT NOMINAL DIAMETER .....6
- 3.4 INSTALLATION POSITIONS .....6
- 4 MAINTENANCE .....7**

## 1 Purpose of this manual and important information

This manual outlines the general requirements for the proper transport, storage, selection, installation, operation and maintenance of Woltman (helix) Water Meter models WPH, WPH2000, WP, WS, WB and WI. It applies to closed circuit (pipeline) installations used to measure the consumption of potable water in domestic and industrial applications. It also applies to volumetric measuring units used with energy meters. An additional information sheet is available for combination water meters such as the WPV models.

This information should assist you ensuring that you meet your legal obligations for the installation of these meters.

Failure to conform to these guidelines invalidates all manufacturer warranties.

### 1.1 *Important information concerning the installation of water meters*

In Germany all water statutes require that the regulations contained in DIN 1988 on potable water in properties must be observed. Furthermore, all the requirements of the PTB (German Federal physical-technical Authority), found in annexes PTB-A 6.1 and 6.2 to the Calibration Regulations of 12 August 1988 or the most recent version, should be adhered to. The German directives for legal metrology to be obeyed are to be found in the "Eichgesetz" (law about measuring and calibration) of or later than 23 March 1992. In many countries in the world, similar regulations apply.

Measuring instruments for business and official usage, health protection, labour protection or radiation protection measures must be approved and calibrated, if a guarantee of measurement accuracy is required.

Measuring instruments must be installed, connected, handled and maintained in such manner that the correctness of the measurement and the reliable reading of the meter's indication is guaranteed.

ZENNER® domestic water meters correspond in size to ISO 4064/1 or DIN 19648-1 and DIN 19625. They are protected against unauthorised tampering by a seal. The seal also shows that the meter has been certified. If this seal is damaged during installation or through subsequent operation, the certification expires. The meter must be removed and recalibrated.

The meter should be preferentially installed in an absolute horizontal position since the measurement accuracy of the meter is at its greatest in this position.

## **2 Handling and dimensioning**

### **2.1 Handling care and shipping**

ZENNER® water meters are precision instruments and should be handled with care in order to avoid damage. They should not be thrown or subjected to impacts and excessive vibration. The meters should be storage-protected from temperatures below 0°C. If the meters have been exposed to very low temperatures, please check if turbine and counter are working properly. A simple check can be done by moving the turbine and looking to the counter. If the counter does not move due to frozen parts, the water meter should be brought to a warmer place to slowly defrost. A sudden water surge onto frozen parts could damage the meter.

To protect water meters against weather and other external factors, ZENNER® water meters are individually packed in boxes and these boxes are placed on a wooden pallet. Other special packaging requirements can be supplied on request.

### **2.2 Receipt and storage**

On receipt of the water meters they should be carefully checked for any possible exterior damage that might have been caused by transport, specially meter casings and flanges.

Water meters should be stored with the counters put upwards in rooms closed, free from any caustic or stinking vapours, etc. at temperatures between 5°C and 30°C and relative humidity of the ambient air up to 80%.

### **2.3 Selecting proper water meter sizes**

To achieve satisfactory measuring results, it is important to choose the suitable water meter type and size for each application. The basic criteria for choosing the proper water meters are the nominal/average flow, the maximal and normal working pressure in the pipeline, the water meters' head loss and the specific application. Other important criteria for choosing proper water meter sizes are: temperature and installation position on a pipeline. Oversized water meters not only increase the capital investment but also considerably reduce the measuring accuracy during periods of low water flow. Undersized water meters can easily be overloaded which may cause premature wearing of parts.

In order to ensure proper operation of a water meter within its range of measurement, a twenty-four hour flow pattern should carefully be determined. For example, on the basis of monthly water consumption taking into account random flow surges.

### 3 Installation requirements

#### 3.1 General

A water meter should be installed in a location that is easily accessible, convenient for readouts, protected against frost and the effect of wiring and gas systems. In case such a spot cannot be found a water meter should be built into a wall.

A water meter should have valves on both the inlet and the outlet that cut off water inflow so that the water meter or its measuring insert can be removed for repair or maintenance. These valves should always be fully opened during the normal operation of the meter.

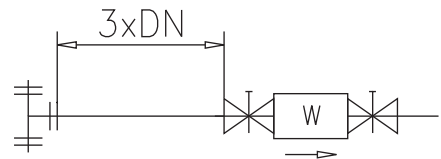

The pipeline section that a water meter is mounted on should be shaped in such a way as to prevent the possibility of air entering inside the meter. The water meter should always be completely filled with water. Therefore the pipeline after the outlet of the meter should not descend below the level of the meter. Pipes bypassing the water meter are only allowed, if they cannot be operated during the normal operation of the meter.

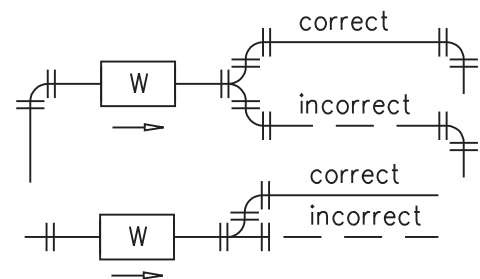

Gate valves, non return valves, pressure reducing valves, and other fittings or incorrectly sized seals, which are installed in front of meters, create turbulence that can have a detrimental effect on meter accuracy. These fittings should be installed behind the meter. A trouble-free straight pipeline with the nominal diameter of the meter must be set up in the flow direction in front of each meter. The length of that pipeline must be at least three times the nominal diameter (3 DN). For DN400 or bigger meters it must be at least the five times the nominal diameter (5 DN). Except for combination meters, no sharp cross-sectional restriction should exist immediately behind the meter. If a service valve must be installed before the inlet to the meter, a suitable flow rectifier should be installed directly on the inlet to the meter.

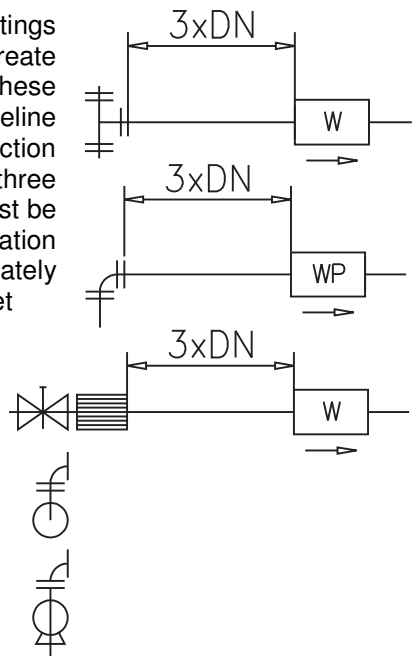

Care must be taken with all connections to water meters. Gaskets should be set concentrically to the pipeline. A water meter must not be installed eccentrically on a pipeline. Gaskets must not intrude into the flow of water.

Water should flow through a water meter in the direction indicated by arrows put on the side(s) of the body.

Pipelines must be flushed and cleaned to remove sand, gravel prior to installing the meter. If impurities exist in the normal water supply, the water meter should be fitted with a filter or dirt box on the upstream end of the meter.







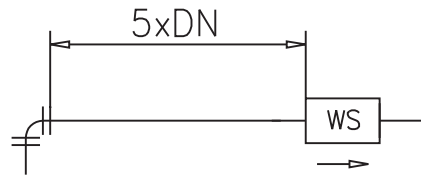



When putting water meters into service, slowly open the valve in front of the meter to prevent overloading or a sudden pressure on the meter's parts, as the meter may still be filled with air.

For WS-meters the length of the pipeline before the inlet of the meter must be at least the five times nominal diameter (5 DN).

A straight pipe, 2DN or longer, should be installed after the outlet of the meter.



Legend:

	Sluice valve open		Water meter (W/WS/WP)
	Flange		Flow Rectifier
	Filter		Space Curvature
	FFR piece		Bend
	Flow direction		Centrifugal pump

### 3.2 Installation in rigid pipelines

For the installation of meters in rigid pipelines we recommend the use of an adjustable adapting pipe to make installation and removal easier. If the meter needs repairing, it should normally be completely removed and replaced with a certified meter. In some cases, only the meter inserts need to be changed. In these cases the bodies remain in the pipelines (except WP).

### 3.3 Installation in rigid pipelines with different nominal diameter

If the nominal size of the meter differs from the nominal size of a pipeline, tapered adapters (reducers) should be used. The use of a one-sided tapering flange pass is prohibited. For pipe size reduction as well as extension, a turbulence-free straight pipeline as described in section 6.1. must be set up in the flow direction in front of each meter. A small head loss is caused by the flange pass.

### 3.4 Installation positions

Another important factor to attend to is the water meters mounting position on a water-pipe network: horizontal, vertical or skew. (see Table). It is not permitted to install the water meters with the counter facing downwards.

Type of water meter	Mounting position			Position of the counter
	Horizontal	Vertical	Skew	
WPH	✓	✓	✓	←↖↑↗→
WP, WI	✓	✓	✓	←↖↑↗→
WS	✓			↑
WB	Vertical inflow – horizontal outflow			↑

Compound water meters should be horizontally mounted on a pipeline without tilting. Well or bore water meters (type WB) are installed in positions where an elbow would be required.

## 4 Maintenance

The accuracy of a water meter decreases over time. This accuracy decrease is accelerated in the presence of aggressive effect of water, particularly if it leaves deposits (iron, magnesia) causing premature wear of the mechanical parts of a water meter. Therefore, every single water meter should – after a reasonable period of operation – be removed and inspected or tested if necessary.

Accuracy should be checked prior to dismantling and cleaning. Chemical compounds that have a harmful effect on materials that water meter parts are made of should not be used. In particular aliphatic hydrocarbons such as petrol, xylene, toluene and some of their derivatives (i. e. acetone) must in no circumstance be used. If parts do need to be replaced, only original manufacturer spare parts should be used.

NOTE: The manufacturer reserves the right to introduce any alterations in order to improve product quality. Those alterations might not be shown in the operating manual, however the main characteristics of a given water meter type will be preserved.

Details are subject to change. The company is not liable for possible errors and/or misprints.  
ZENNER<sup>®</sup> is a registered trademark of ZENNER International GmbH & Co. KG.